

First Line of Song	Missing Last Word (Puzzle Answer)	Song Title (Puzzle Title)	Verified Correct
A fool ignores each obstacle he...			
For you I would commit an act of...			
I do admire your skill with that...			
I just can't wait to see you in...			
I told you once that I needed some...			
I'm paralyzed, unable to...			
If love's the sweetest treat, then you're the...			
My friends hear your demands and think you're...			
The last time that I heard you say...			
The way you look requires no...			
The whole firm knows that you're the cutest...			
We'll paint the town and have a bit of...			
When first we met, I stumbled, seeming...			
With every smile you fill me with...			
You saved me from a life of naught but...			

- **Submit 3 completed lines at Venue 1 to get more puzzles and gain access to Venue 2**
- **Submit 8 completed lines at Venue 2 to get more puzzles and gain access to Venue 3**
- **Submit 13 completed lines at Venue 3 to gain access to the BAPHL of the Bands**

919 1: JOHNNY D ' S UPTOWN

This venue features an eclectic mix of well-loved local acts along with some more off-beat national touring artists.

To get a gig, find the “**booking manager**” (who will be out in front with a clipboard) and give the titles and complete first lines of **three of your songs**. In case you have forgotten, you complete a first line by figuring out the answer word or phrase to a puzzle and then adding it to the uncompleted first line that it fits with the best.

**** Check in at Johnny D's by 1:00pm, no matter how many puzzles you have solved! ****

Also, be sure to check out some of the posters in the area for upcoming Mystik Spiral shows. On a related note, I would advise **not leaving Davis Square** until after you have solved *We're Thinking of Changing It*.

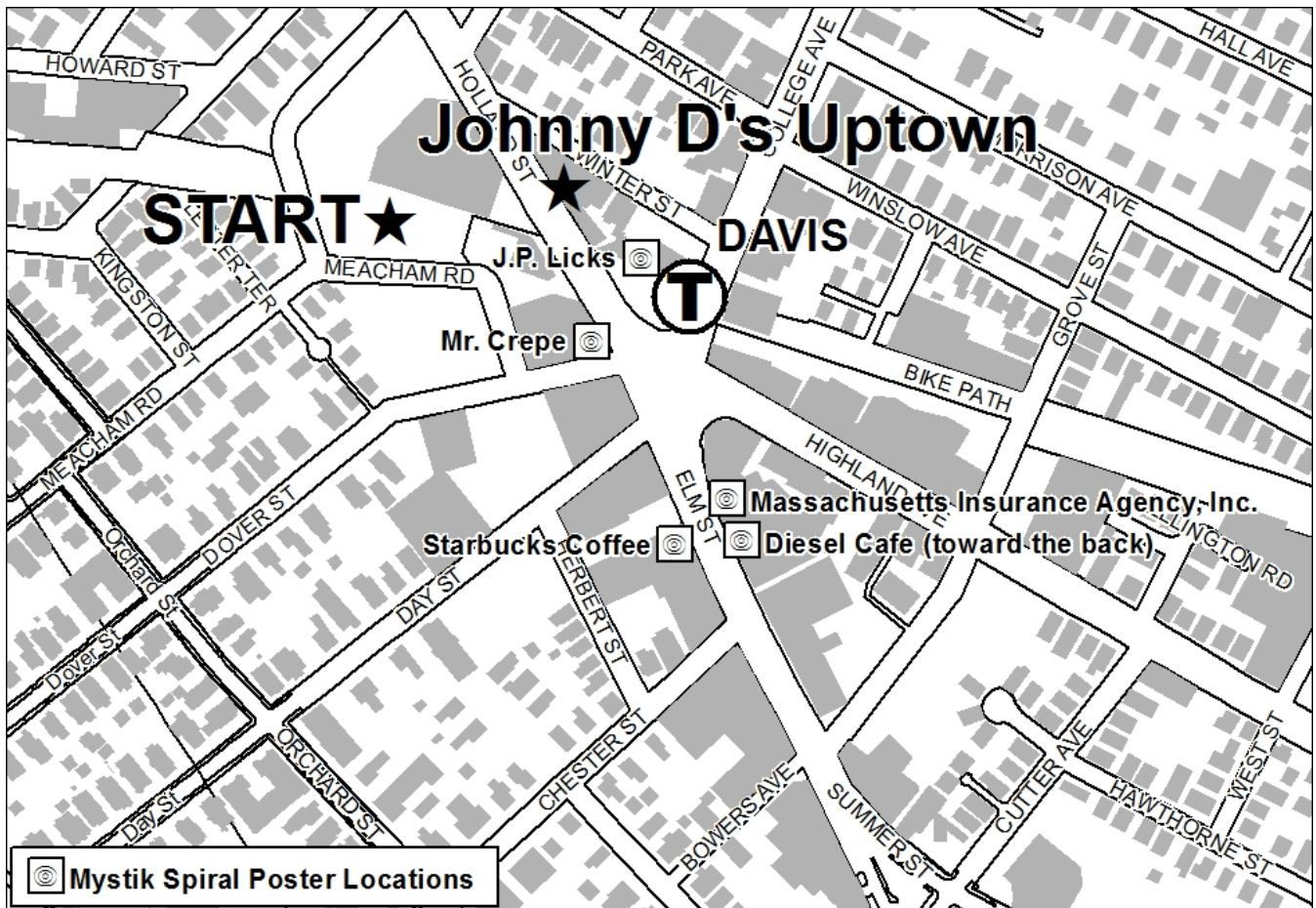

NOTE: PLEASE DO NOT REMOVE ANY POSTERS! If you think you have searched a location thoroughly and a poster isn't there, call your agent or tell the person at Johnny D's.

ANGRY WORDS

In between gigs, there's a lot of downtime to mess around with your mobile phone and curse those diabolical numbers that have stolen your letters! Now it's up to you and your team of brave words to get them back. Each of the sixteen words below can take out two of the blocks in their castle. If you knock the numbers all out, you should be able to locate the letters they've stolen.

A	B	C		D	E	F
G		H		I		
J	2		K	3		L 7
N	2		O	3		P
R			S		T	
U	1		V	4		W 8
Z	1		α	4		γ 6
ε				ζ		

ALTERNATES • AUTOMATA • DOMAINS • EDUCATION • EIGHTH • GRAMMARIAN • HEADACHE • MAINLAND • MEGACHIROPTERAN • PEDAGOGICALLY • REPERTOIRE • SLANDER • TERRA • UBIQUITOUS • UNDERSTUDY • VERISIMILITUDE

- A** Contains all five vowels exactly once
- B** Only contains letters from the first half of the alphabet
- C** Contains a six-letter palindromic string
- D** Is made up of a string of two-letter U.S. State postal code abbreviations
- E** Adding an I to the front creates a new word where the old first letter is now silent
- F** Becomes part of a bike if you replace its last nine letters with an L
- G** Anagram of a presidential surname
- H** Consists of one consonant and one vowel repeated three times each, and no other repeated letters
- I** Becomes a word for how a Vulcan acts if you replace its first five letters with an L
- J** Consists entirely of letters with a vertical axis of symmetry
- K** Removing the first two letters produces a word that describes a large portion of the original word
- L** Moving the last letter to the front makes a new word
- M** Moving the first letter to the end gives the last name of a famous Ann
- N** Becomes a color when each of its letters are shifted 13 places in the alphabet
- O** Letter banks to a word meaning "edge of a sheet of paper"
- P** Contains a world capital
- Q** Can be typed entirely on the top row of a Qwerty keyboard
- R** Anagrams to a professional who might win an Academy Award
- S** Contains a Greek letter
- T** Can change one musical note to the subsequent note to make a new word
- U** The second half is the first name of a famous spy
- V** Begins and ends with the same pronoun
- W** Alternates vowels and consonants
- X** Can be split into two substrings, one containing all the vowels and one containing all the consonants
- Y** Is made up of a string of two-letter elemental abbreviations
- Z** Contains a five-letter medieval currency
- α** Becomes a synonym for "critic" if it is split into two pieces and the pieces are switched
- β** Shares its consonants, in order, with a word meaning "flower arrangements"
- γ** Appears in one of these rules
- δ** Contains a string of four consecutive letters in the alphabet
- ε** Contains five consecutive Roman numeral characters in a row
- ζ** Its halves can be swapped to give a two-word phrase

DINING WITH DISASTER

When Mystik Spiral are out on tour, they face the constant quandary of how to eat well on the road. Good nutrition is generally overlooked; the real issue is that Jesse only likes eating pizza, and Max only likes submarine sandwiches, which means that for every meal (lunch and dinner, because what kind of self-respecting rocker is up in time for breakfast?), the band has two options to pick from.

Use the facts below to figure out what they ate during their last 10-day tour. You can use the chart at the bottom of the page to help record your answers; for maximum fun, we recommend drawing cute pictures like the ones provided on the right.

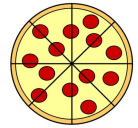

1. There were six meals where the band ate nothing to save money for beer. These meals occurred on five different days; no two of these days were consecutive. For every other meal, the band had either pizza or subs.
2. After the next-to-last time the band had subs, they had pizza for their next two meals.
3. At one point during the first half of the tour, the band had pizza for both meals of two consecutive days. This was referred to as “the incident” and regarded as a terrible mistake, so they skipped lunch the next day, and they never had the same food more than once a day for the rest of the tour.
4. The second time during the tour that the band ate subs was for dinner on Day 5, after a tasty pizza lunch earlier that day.
5. The band had the same number of pizza lunches as pizza dinners, but they had more sub lunches than they had sub dinners.
6. One night of the tour, the band had some really mediocre pizza for dinner, so Max insisted on getting subs for lunch the next day.
7. On the last three days of the tour, the band had lunch each day, alternating back and forth between pizza and subs (starting with one or the other).

Day	1	2	3	4	5	6	7	8	9	10
Lunch										
Dinner										

DOUBLE ← CROSSED

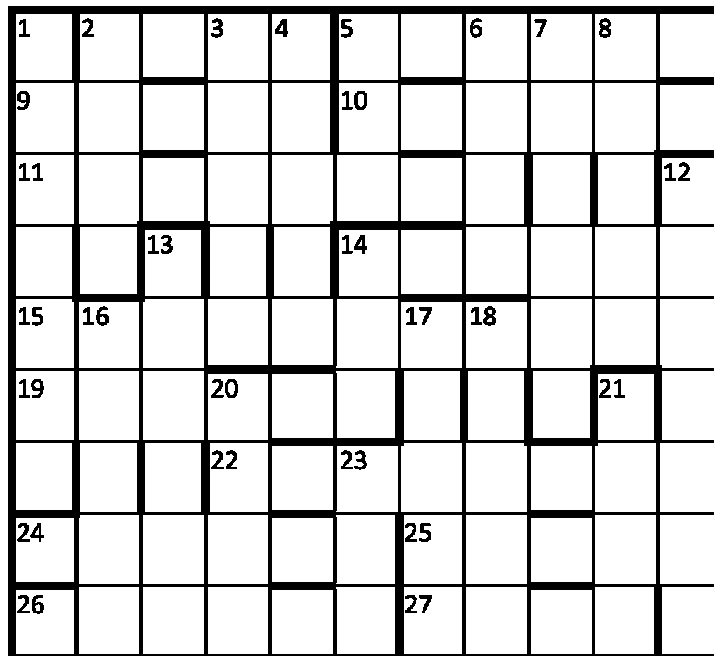

ACROSS

- 2 Former political party advocating transcendental meditation (2 wds.)
- 5 You make Aretha feel like one (2 wds.)
- 9 Famous violin maker
- 10 Communicate or bestow, as knowledge upon a mentee
- 11 Dog breed from China
- 14 Not widely understood
- 15 ZZ Top hit featuring the lyric, "Black shades, white gloves" (3 wds.)
- 19 Van Gogh painting of flowers
- 22 Skilled marksman
- 24 Literally, "tied together" in music
- 25 *My Cousin Vinny* Oscar winner
- 26 Document cited in a divorce hearing
- 27 Dick Tracy villain named for the shape of his head

DOWN

- 1 Ahab or Picard, for example
- 2 FBI agents, slangily (hyph.)
- 3 Reason to be glad you packed a jack (2 wds.)
- 4 Sitcom set at a Nantucket airport
- 5 Meet one's maker
- 6 Group of oil-rich nations (abbr.)
- 7 Address for a lady
- 8 Sports or concert venue
- 12 Woodstock closer
- 13 Card game with contracts and slams
- 14 Beast of burden
- 16 Appliance used after another appliance
- 17 Overact
- 18 Policeman or podiatric condition
- 20 Diddy's first name
- 21 Hang on to
- 23 Old-timey high school dance

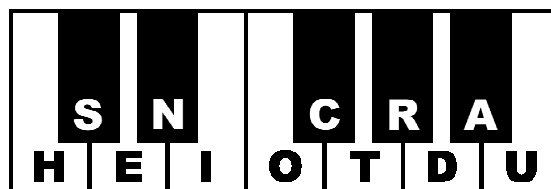

FUN SIZE

It's perfectly fine if the dressing room has brown M&Ms, but I do insist that my chocolate be entirely intact!

If you get the pieces of this broken bar back together again, you'll get a clue to this puzzle's six-letter answer. Black lines represent spaces between the clue words. The pieces are arranged in alphabetical order by their answers.

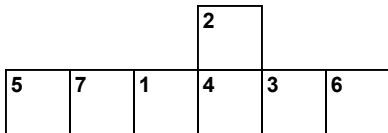
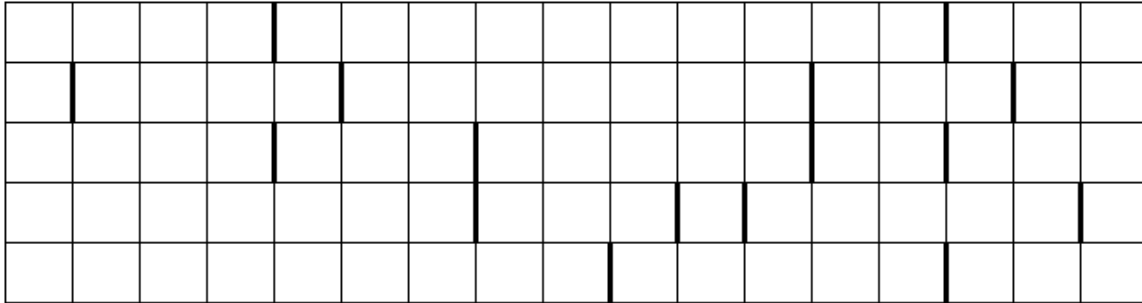

Deliberately misleading stories

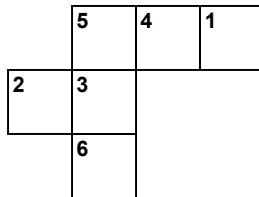

Kansas City's football team

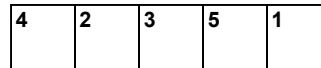

Markers or IOUs

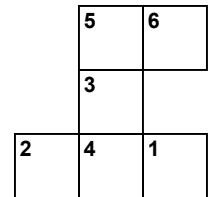

Occur to suddenly (2 words)

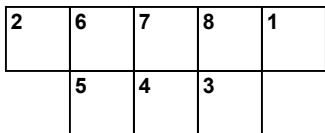

Short-lived, as a moment

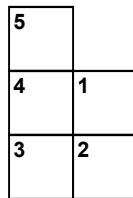

Bunch or collection

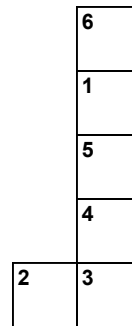

Did damage to

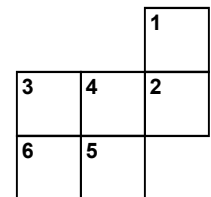

"As a result of this document or official statement"



Word under every Facebook post



A few

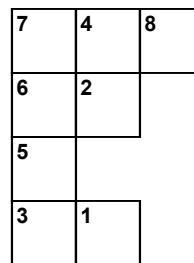

With less air circulation, as a room

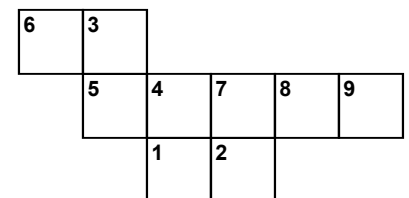

Professional you might bring your problems to

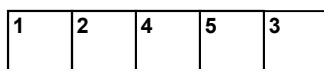

Shakespearean character from Athens

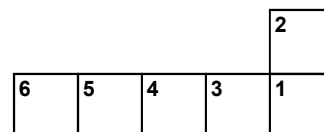

Moved back and forth, like a dog's tail

WE'RE THINKING OF CHANGING IT

Changing your band's name is always something you want to be thinking about. All the biggest bands change their names until they find one that works. Inspiration can hit you like a brain freeze, so you better be ready to take advantage when the right idea comes along.

You wouldn't believe the names of some of the bands that play with Mystik Spiral. I've got no clue how they come up with them. I'd tell you some if I could remember what they are. Actually, I bet you can find posters for their upcoming shows around Davis Square. I think they've got one show a month over the next five months.

Check the map in your Gig Info Sheet for the locations of posters in the area.

October 15, 2012

MYSTICAL

with

**GIRL SCOUT
FAIRY SWATTER**

all ages

Jamaica Lounge
36 Davis Square, Somerville

November 4, 2012

MYSTICAL

with

SKULL  TAN  SCRAP

all ages

Jamaica Lounge
36 Davis Square, Somerville

December 8, 2012

MYSTICAL

with

**INKY
BRONX
CHILD**

all ages

Jamaica Lounge
36 Davis Square, Somerville

JANUARY 1, 2013



MYSTICAL SPHERA

with

GENTLE ROUT

all ages

Jamaica Lounge
36 Davis Square, Somerville

February 1, 2013



Mystical

with

CULTURE '10

all ages

Jamaica Lounge
36 Davis Square, Somerville

919 2: TOAD

This hole-in-the-wall joint (as it were) features all local bands performing seven nights a week. It has a more hard-rock feel than the more bluesy, folksy Johnny D's and it tends to draw a somewhat more lively crowd.

To get this gig, you will need to impress the booking manager with the titles and first lines for **eight of your songs**. But don't get too worried; you are free to re-use any of the songs that landed you your gig at Johnny D's.

**** Check in at TOAD by 4:00pm, no matter how many puzzles you have solved! ****

Also, I would advise **not leaving Porter Square** until after you have solved *Alcoholic Haze*.

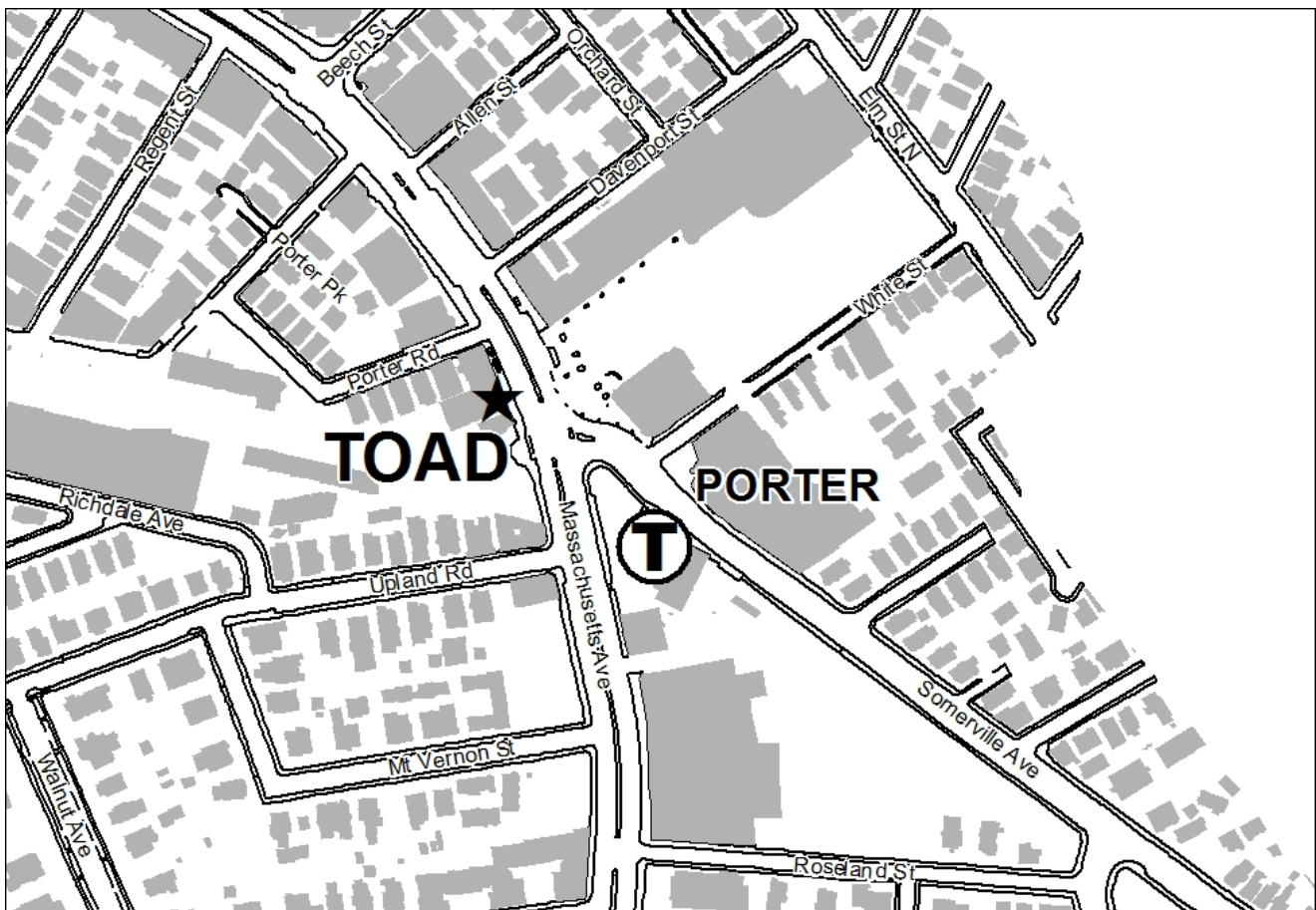

ALCOHOLIC HAZE

Believe it or not, I was just at a show in Porter Square last night! I wish I could remember exactly where I went afterwards, but after a few too many the whole night became a tangled mess. Can you help me figure out where I ended up?

Well naturally I started at, um, what's it called ...

... right, and when I left, I turned right. Or maybe it was left? All I remember is I went by some kind of Asian restaurant ...

... and I remember they had some rice dish, it had a weird name and I remember that the English translation seemed oddly appropriate at the time ...

... but they weren't open, and so I tried going to some other place nearby ...

... and they had just closed I think, but they had something that sounded kind-of funny, like maybe an opera-singing sandwich or something like that ...

... and so I went around the corner to another place, I remember thinking it was not nearly as old-fashioned as it sounded ...

... I decided not to go in, but I laughed because in the window there was a sign where they had misspelled a word. They had to fix it with a marker to get the right word ...

... but I shouldn't talk, I'm not a great speller myself. I'm especially terrible at punctuation too. I always leave out apostrophes when I need them. But I'm not sure why I'm telling you that ...

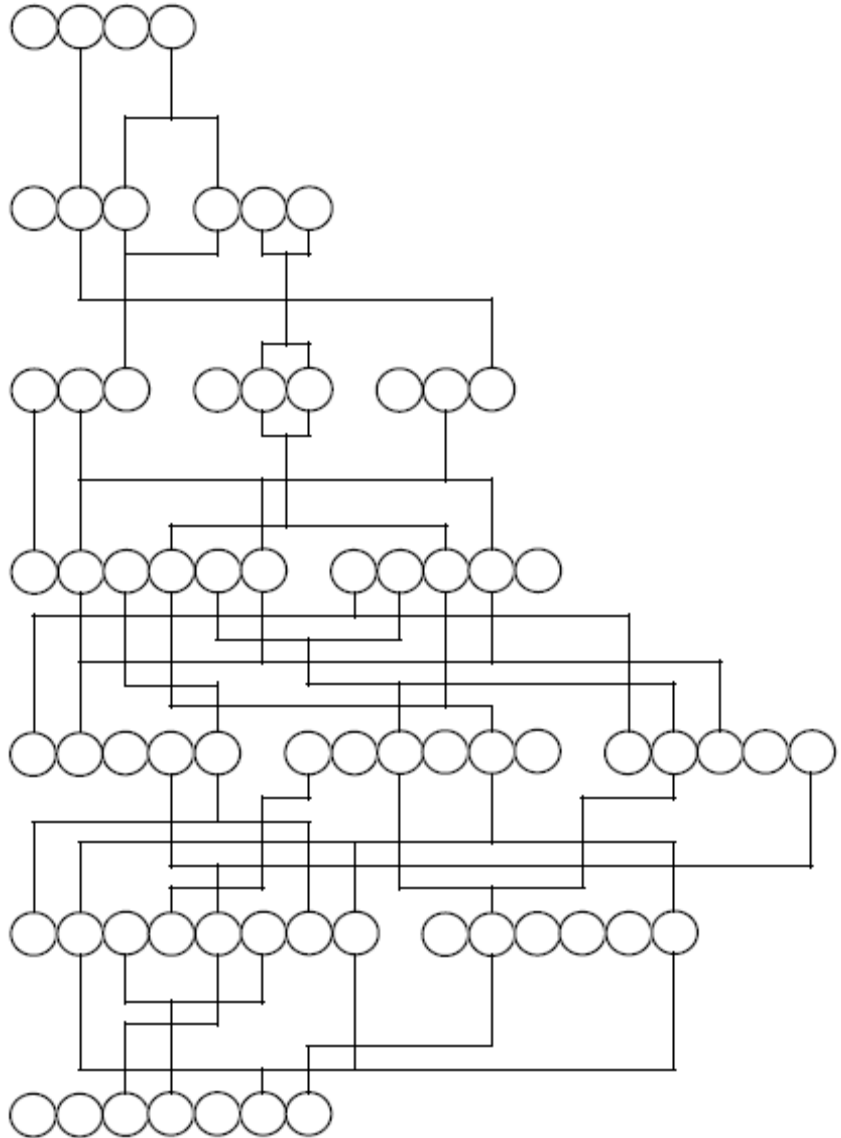

ALCOHOLIC HAZE *continued*

... oh sorry, I got distracted.
What was that funny word?

Oh yeah. I don't really like that.
So I went across the street to
someplace a little more up-
market ...

... and then things started
getting even more hazy, but I
remember thinking that I should
go back in the early afternoon
for something that sounded
really tasty ...

... but then I think I went to
some other place because I got
a different kind of craving ...

... and I remember looking at
their display case and thinking
that they knew exactly what I
was in need of ...

... but I think that was closed
too, and after ranting for a while
about flagrant false advertising,
I went someplace I knew would
be open ...

... and I just had to order
something off a certain part of
their menu because it had a
really cool punny name ...

... and then on the way out of
Porter Square I walked by a
place, and I have no idea
whatsoever what it was, but for
some reason I feel like it's
exactly what I need today ...

... ah, of course!

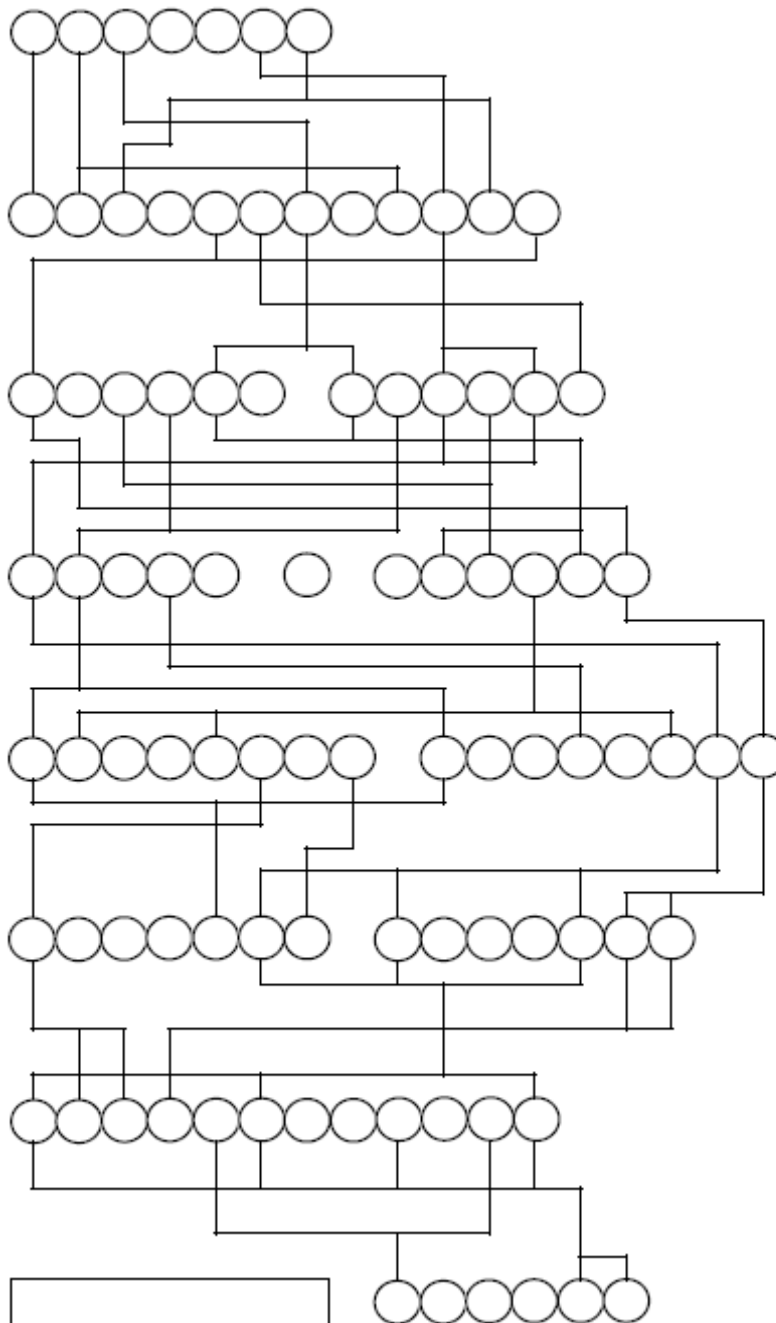

BIG SHOW TONIGHT *continued*

GIG 1

```

      X X X
      X X X X X X
      X X X X X X
      X X X X X X X
      X X X A X X X
  
```

D	X	A	X	X			
X	M	X	X	X			
X	X	X	X	X			
	X	B	X				
X	X	X	X				
X	X	X	X				

GIG 2

```

      X X X M X X
      X X X X X X
      X X G X X X X
      X X X X M X X
  
```

X	X	X	X				
X	X	D	X				
X	X	X	X				
M	X	X	X	X			
X	X	X	X	X			
D	X	A	X	X			
X	M	X	X	X			

GIG 3

```

      X X X X
      X G X X X X
      X X A X X X A
      X X X X X X X
      X X X X X X X
  
```

M	X	X					
X	X	X	X				
X	X	X	M				
X	M	X	X				
X	X	X	X				
X	X	X	X				
M	X	X					

CARPET

D	I	T	C	H	E	S
A	C	R	Y	L	I	C
L	E	P	R	O	S	Y
O	P	E	N	I	N	G
U	N	A	W	A	R	E
K	I	N	G	D	O	M
F	A	U	C	E	T	S

CALENDAR GUY

The hardest part about getting the band together is simply finding the time...

JAN 15 1:00 p.m. Game show audition (practice buying vowels!)	JAN 17 9:00 p.m. <i>Sirius or Polaris</i>	JAN 19 12:30 p.m. Write to "School of Rock" star	JAN 20 9:00 p.m. "Golden Girls" actress	FEB 20 3:00 p.m. Listen to <i>The Godfather of Soul</i>
FEB 22 10:00 a.m. Fix part of a carillon	MAR 18 7:00 p.m. Buy item in a menorah	APR 1 11:00 a.m. Very silly person (appropriately enough, today)	APR 3 8:00 p.m. Read <i>Romeo and Juliet</i> , e.g.	APR 6 7:00 p.m. "Buffy" actor and "Family Guy" voice
APR 26 10:00 a.m. Find <i>Suave Max</i> or <i>Garnier Fructis Full Control</i>	APR 28 11:00 a.m. <i>Thackeray</i> novel due	MAY 5 1:00 p.m. Return this to the library	MAY 8 4:30 p.m. "Cabaret" emcee	MAY 23 3:30 p.m. <i>You and me</i>
JUN 10 10:00 a.m. Rewatch <i>Ali</i> and <i>Spinks</i>	JUN 22 12:30 p.m. Get the same score	JUL 1 12:00 p.m. Ride the merry- go-round	JUL 5 2:00 p.m. Fly to <i>Windy City</i>	JUL 14 9:00 a.m. Buy vodka, triple sec, cranberry juice, lime juice
JUL 15 7:00 p.m. Evening with <i>Ms. Lennox</i>	JUL 26 10:30 p.m. <i>Money to the landlord</i>	AUG 6 1:00 p.m. <i>Mick Jagger</i> , perhaps	AUG 9 6:00 p.m. Head to the ocean east of here	AUG 27 10:30 a.m. Sign up for the army
SEP 3 2:00 p.m. Head to <i>Ann</i> or <i>Cod</i>	SEP 13 5:00 p.m. Legal action against someone	SEP 23 8:00 a.m. <i>Gasps for air</i>	SEP 25 4:00 p.m. Dance like <i>Chubby Checker!</i>	SEP 28 8:00 p.m. <i>Vegas</i> magician <i>David</i>
SEP 30 8:00 p.m. Get some <i>Smucker's</i> or <i>Welch's</i>	OCT 12 1:00 p.m. Visit small offshoots of the river	OCT 26 6:00 p.m. Pay attention, particularly to sounds	NOV 5 3:00 p.m. <i>Quiet</i>	NOV 26 7:30 p.m. Buy silver stuff for the tree
	DEC 11 9:00 p.m. Play ukulele, like the guy who sings "Tiptoe Through the Tulips"	DEC 25 2:00 p.m. Christmas party (<i>Bah! Humbug!</i>)	DEC 28 11:00 p.m. Listen to reggae artist <i>Bob</i>	

CALENDAR GUY *continued*

JANUARY						
1	2	3	4	5	6	7
8	9	10	11	12	13	14
15	16	17	18	19	20	21
22	23	24	25	26	27	28
29	30	31				

FEBRUARY						
			1	2	3	4
5	6	7	8	9	10	11
12	13	14	15	16	17	18
19	20	21	22	23	24	25
26	27	28	29			

MARCH						
				1	2	3
4	5	6	7	8	9	10
11	12	13	14	15	16	17
18	19	20	21	22	23	24
25	26	27	28	29	30	31

APRIL						
1	2	3	4	5	6	7
8	9	10	11	12	13	14
15	16	17	18	19	20	21
22	23	24	25	26	27	28
29	30					

MAY						
		1	2	3	4	5
6	7	8	9	10	11	12
13	14	15	16	17	18	19
20	21	22	23	24	25	26
27	28	29	30	31		

JUNE						
					1	2
3	4	5	6	7	8	9
10	11	12	13	14	15	16
17	18	19	20	21	22	23
24	25	26	27	28	29	30

JULY						
1	2	3	4	5	6	7
8	9	10	11	12	13	14
15	16	17	18	19	20	21
22	23	24	25	26	27	28
29	30	31				

AUGUST						
			1	2	3	4
5	6	7	8	9	10	11
12	13	14	15	16	17	18
19	20	21	22	23	24	25
26	27	28	29	30	31	

SEPTEMBER						
						1
2	3	4	5	6	7	8
9	10	11	12	13	14	15
16	17	18	19	20	21	22
23 30	24	25	26	27	28	29

OCTOBER						
	1	2	3	4	5	6
7	8	9	10	11	12	13
14	15	16	17	18	19	20
21	22	23	24	25	26	27
28	29	30	31			

NOVEMBER						
				1	2	3
4	5	6	7	8	9	10
11	12	13	14	15	16	17
18	19	20	21	22	23	24
25	26	27	28	29	30	

DECEMBER						
						1
2	3	4	5	6	7	8
9	10	11	12	13	14	15
16	17	18	19	20	21	22
23 30	24 31	25	26	27	28	29

CHEMISTRY BETWEEN US

Words after reactions	Reactions applied		
FRPHIMGEAPRR	◆	&	☎
AEUNBXIBR	📄	📁	♈
BBAZZCAFE	⌘	□	♎
MBRCUBASCTY	⌘	📁	⌚
EUNSPRAFE	□	♈	☎
EURMGWCAD	♎	♈	◆
NBCAMFRENT	📄	♎	&
NBBSIGSCNG	📄	📁	⌚
PRCHSCCABATY	⌘	⌚	☎
MGERMOFENFRICS	□	◆	&

Words before reactions are applied

- Chemistry class subject
- Demonstrating fluctuation
- Detail in the fine print?
- Eating disorders
- Large entertainment venue
- Heading toward Canada
- Moving to another department
- Process at the end of a weapons ban
- Result of testosterone
- Snowing extremely hard

NOTE: When subtracting, place the higher number first.

⌘	? - ? = ?	♎	? + ? = ?
📄	? + ? = ?	♈	? - ? = ?
📁	? + ? = ?	◆	? - ? = ?
⌚	? + ? = ?	&	? - ? = ?
□	? + ? = ?	☎	? - ? = ?

_____ / _____ / _____ = ?

OFF OUR ROCKERS

One uncomplicated
romantic dalliance
(1 6 5)

In Box 7, write...

Negative reaction to a
vampire in animal form
(3 8)

In Box 1, write...

Crack encoded places
where whirlybirds take off
(8 9)

In Box 3, write...

Malevolent people who
root for non-nerdy athletes
(4 4 4)

In Box 10, write...

Jesters making out with
each other (5 7)

In Box 6, write...

14-line poems about large
African apes (7 7)

In Box 12, write...

Dinner and a movie with an
extra from Baywatch (9 4)

In Box 2, write...

Official proclamation
concerning an Andean pack
animal (5 5)

In Box 11, write...

Require a magical
incantation to finish putting
on jeans (4 3 5)

In Box 13, write...

Small sharp objects used by
tailors seeking revenge
(7 7)

In Box 8, write...

A series of online posts
about a precipitation
demon (4 5 6)

In Box 4, write...

The summertime shoe that
comes after the first seven
(6 5)

In Box 9, write...

For-profit website providing
social services to the
disadvantaged (7 3 3)

In Box 5, write...

[Remove A, anagram]

... the letter A, shifted ...

[Insert B, anagram]

... the letter B, shifted ...

[Remove C, anagram]

... the letter C, shifted ...

[Remove D, anagram]

... the letter D, shifted ...

[Remove E, anagram]

... the letter E, shifted ...

[Remove I, anagram]

... the letter I, shifted ...

[Insert K, anagram]

... the letter K, shifted ...

[Remove L, anagram]

... the letter L, shifted ...

[Remove N, anagram]

... the letter N, shifted ...

[Insert P, anagram]

... the letter P, shifted ...

[Remove R, anagram]

... the letter R, shifted ...

[Remove S, anagram]

... the letter S, shifted ...

[Insert W, anagram]

... the letter W, shifted ...

OFF OUR ROCKERS *continued*

Bean-like legumes frequently eaten in the south (5-4 4)
 ... 10 positions earlier in the alphabet

Country singer Clint's Saturday (5 7)
 ... 1 position later in the alphabet

The three elements that aren't water (5 4 3 4)
 ... 3 positions earlier in the alphabet

Place to put a fire-extinguishing Chapstick (7 4)
 ... 4 positions earlier in the alphabet

Golden Arches burger made from speedy cedar or teak? (9 3)
 ... 6 positions earlier in the alphabet

Corpses that appreciate what they've been given (8 4)
 ... 8 positions earlier in the alphabet

A bill that would normally have Abraham's face but has Andrew's instead (7 4)
 ... 1 position earlier in the alphabet

The royal men who reign over Trotsky (5 2 4)
 ... 2 positions later in the alphabet

Had a higher score than a dirigible (3 8)
 ... 5 positions later in the alphabet

First letter of the alphabet made of gold, silver, or bronze? (9)
 ... 9 positions later in the alphabet

Extremely spicy ingredients like cayenne or habanero (3 3 5 7)
 ... 3 positions later in the alphabet

Objects that gather no moss? (7 6)
 ... 8 positions later in the alphabet

Lettuce having a conversation (7 5)
 ... 7 positions earlier in the alphabet

1	2	3	4	5	6	7	8	9	10	11	12	13

FINAL 919: MIDDLE EAST

Middle East is one of the premiere music venues in the Boston area. Playing the Middle East is a big deal for an up-and-coming rock band. Even if you're only playing the Upstairs, if you can land a gig here, you've done pretty well for yourselves.

To get this gig, you'll need to really impress. Find the "booking manager" and preview thirteen of your songs with their titles and first lines. I think that may be enough to get you in the door, although you might be asked to give a little extra to seal the deal...

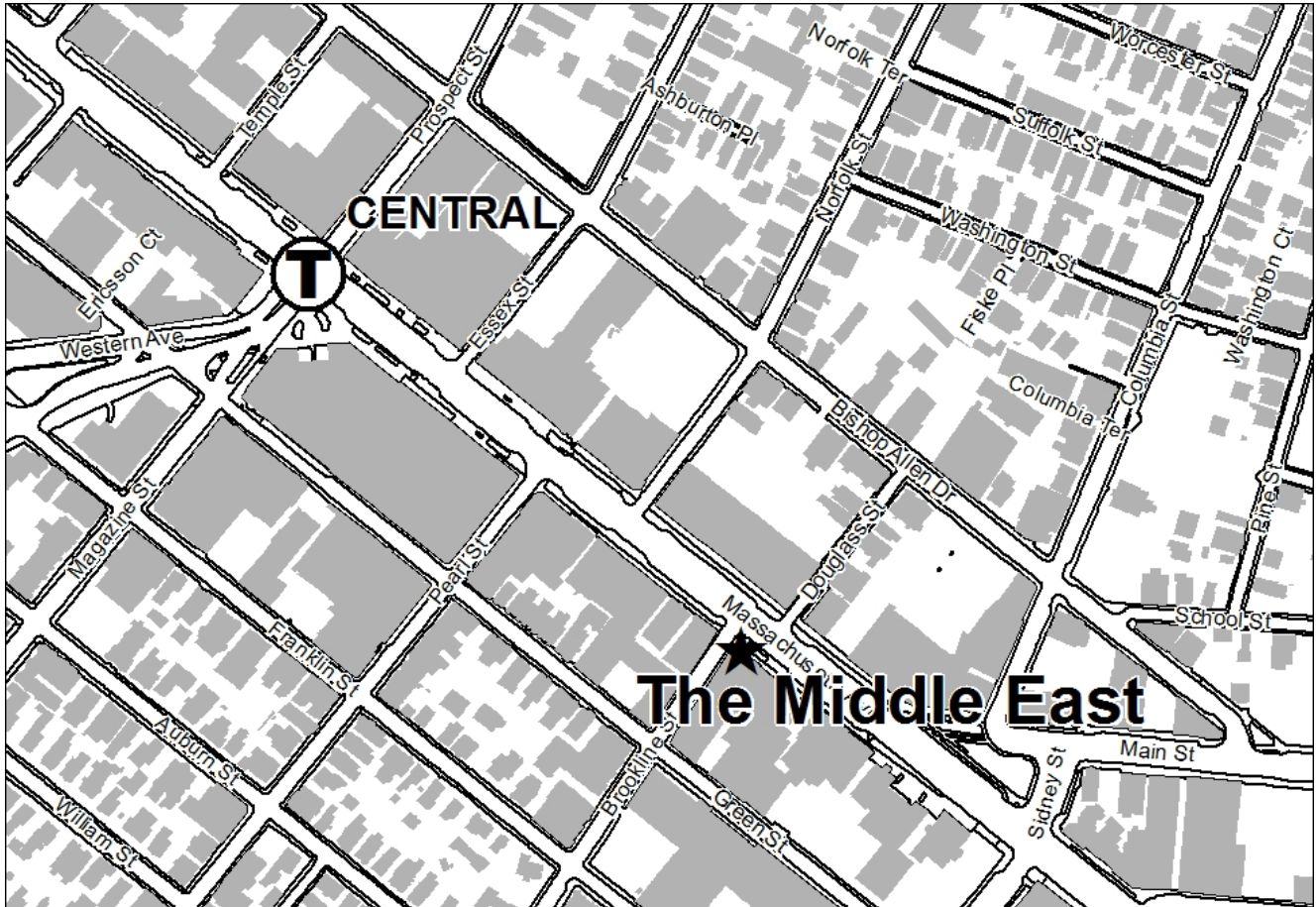

**** Be at the Middle East by 5:30pm for the wrap-up party, no matter how many puzzles you have solved by then! ****

BACK IN THE DAY

I remember Central Square in the old days. It used to be true rock and roll. Now it's gone corporate. And once things go corporate, the suits keep trying to change things to make them more marketable ... (With thanks to the Cambridge Historical Commission)



BACK IN THE DAY *continued*

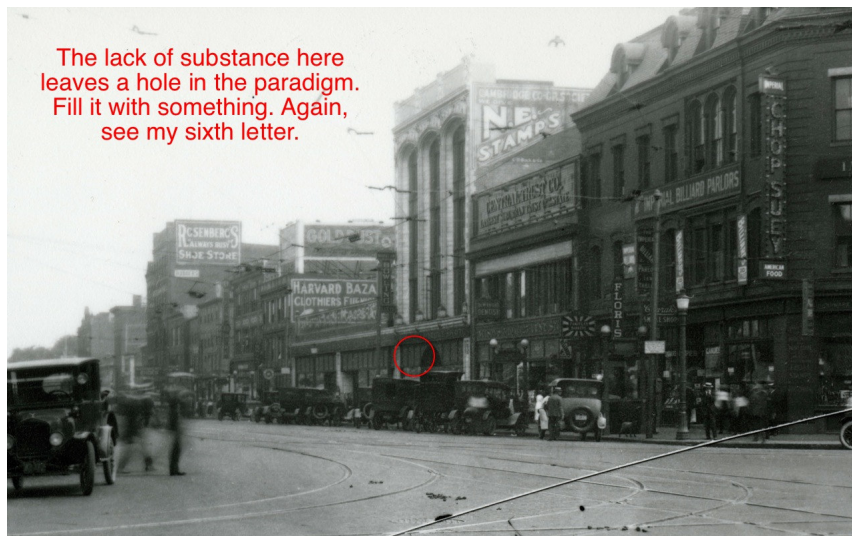

BAPHLG

CLOSE ENOUGH FOR JAZZ

When you're improvising, sometimes it's the bits you leave out that really make the difference.

Answers are clued in order, but when writing in the grid entries, you'll have to skip certain squares, sometimes even within an answer.

	1	2	3	4	5	6	7	8	9	10	11	12	13
1													
2													
3													
4													
5													
6													
7													
8													
9													
10													
11													
12													
13													
14													

Across

- 1 Sudden convulsive movement • Finger or toe
- 2 It's smaller than a city • Not any
- 3 Solo • Lose intensity or luster
- 4 Poorly mannered • Nameless, briefly
- 5 Highlight of many an opera • Strike down from the heavens
- 6 Set of methods
- 7 Later, not-as-sharp years • County in eastern England
- 8 Ease up on the gas • More recent
- 9 Withdrew, as floodwaters • Director Scott
- 10 Cattle ranch sounds • Totally focused
- 11 Ornamental tree • Back in style
- 12 First Biblical character to die • Common cook-book verb
- 13 Senate Majority Leader since 2007 • Paying customer, as of a lawyer
- 14 Items connected to a ring • White, sticky stuff

Down

- 1 Certain valuable musical instruments, briefly • Start on a journey
- 2 One let go early
- 3 Came to a landing, as a bird • Seabird with blue feet
- 4 "The March King" • TV series based on the novels of forensic anthropologist Kathy Reichs
- 5 When said twice, a hit for The Mamas and the Papas • Loose talk
- 6 Network of underground pipes • Best Supporting Actor nominee for "The Aviator"
- 7 London's theatre district
- 8 Decides what to call • Actor Bana
- 9 Cotton twill fabric, frequently used in pants • Twisting, spirally pattern
- 10 Knowledge • Actor who played Ricky
- 11 Small beard • Some Starbucks orders
- 12 Back-of-the-book material • Many a "Reader's Digest" article
- 13 Very small • Rich, cake-like dessert

EVIL GENIUS TEENAGE CUBISTS

Are Mystik Spiral actually suggesting you write a theme song for a wacky cartoon foursome? Sounds like it...

FALDO	CARDIAC	LACHEY	MR. BURNS	MR. SLATE	MAPLE	NIAGARA	ANGEL
YEARLY	NOLTE	MR. GRAHAM	MR. SPACELY	NOLAN RYAN	ELM	OAK	VICTORIA
SNOUT	PROBOSCIS	SCHNOZ	SUPREME	ARROW SHOOTER	PRESENT ADORNER	VIOLIN PLAYER	BEELZEBUB
HEROD	SCOTTIE PIPPEN	DENNIS RODMAN	SANDALS	DISTRICT	SMOKING	LENTIL	GRANDE
ALBERTA	KARNAK	MICHAEL JORDAN	APPELLATE	DEMAND	DRINKING TO EXCESS	VENTI	XEROX
LEAR	THE ONE THAT STAYED HOME	VINOGRADOV	THE ONE THAT HAD NONE	NAIL-BITING	ROGER	CHRISTMAS CANDY	TALL
TUTANKHAMUN	THE ONE THAT WENT TO MARKET	CASHEW	FILBERT	PRINCE PHILIP	MACADAMIA	WALKING AID	SUGAR SOURCE

$$(\square + \square = \dots)$$

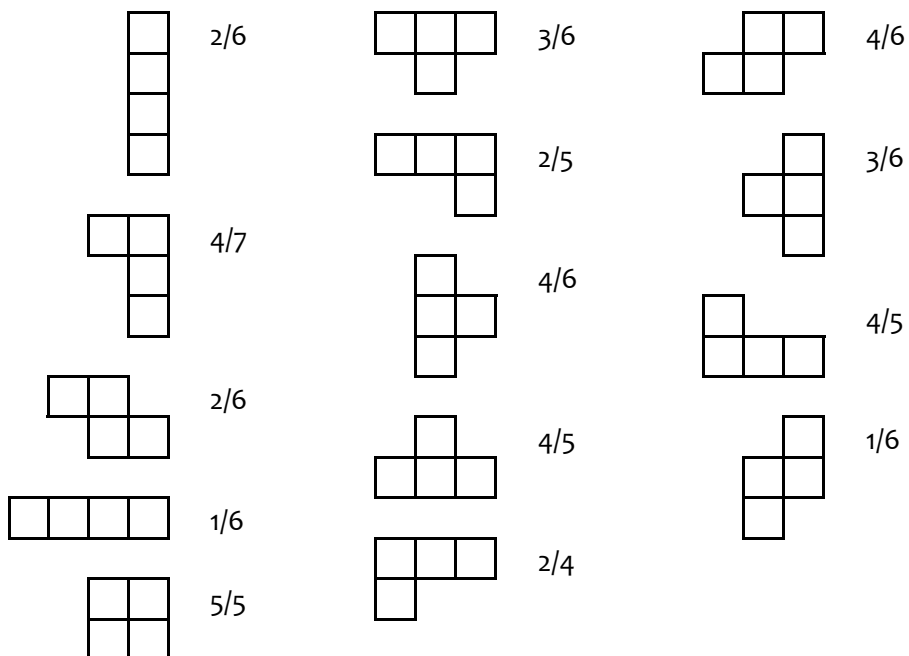

ROPIN', RAISIN' AND RUSHIN'





A good country song makes you feel like a cowboy. More specifically, the first verse makes you feel like you're ropin' cows, the second verse makes you feel like you're raisin' 'em, and then the third makes you feel like you're rushin' 'em off to the slaughterhouse. Yeeeeeheh!

* *Ropin' (Slitherlink)*: Draw lines along the edges of the squares to form a single closed loop (the rope). The rope cannot touch or cross itself. Each square with a number in it indicates how many of the edges of that square are part of the rope. **In addition, each of the cows must be inside the rope.**

* *Raisin' (Corral)*: Draw lines along the edges of the squares to form a single closed loop (the corral). The corral cannot touch or cross itself. Each square with a number in it is inside the corral and indicates how many squares inside the corral, *including the square itself*, are visible from that square (unobstructed by the corral border) in any of the four directions (up, down, left, or right). **In addition, each of the cows must be inside the corral AND the corral may not contain any 2x2 squares.**







* *Rushin' (Shikaku)*: Draw lines along the edges of the squares to divide the entire grid into rectangles (crates). Each crate must contain exactly one number, which indicates the area of that rectangle. **Most of the crates will contain at least one cow, but some of them will instead contain important equipment left over from when you were ropin' and raisin'.**

ROPIN'

3			1		3		1			3	2
				2					1		
	0		3		1		2				
									1		3 3
	3				3			1	2		
			0				1		2		3
3		2		2	1		3		1		
		2					0				1
	1		0				2	1		3	

ROPIN', RAISIN' AND RUSHIN' *continued*

RAISIN'

			8		4					4
										
	3		8				4		7	
						2			7	
										
		12	17		17				18	
5										
						2	5			
6			3		8					

RUSHIN'

	2		6					7		
					2					
	4		2						9	
								10		
						9				
		6	3	9						
6										12
	3		4				6			
					5				3	

The Vinyl Countdown

Clues in this grid are entered clockwise around the spiral from the outside in, in the order they are provided. It is up to the solver to determine where each entry begins and ends. Within each octant wedge, the eight outermost letters will be rearranged with one dropped in the seven letters in the next ring, and so on until only one of the eight letters is left in the center ring. We've provided the enumerations for the first twenty-nine answers; after that, you're on your own...

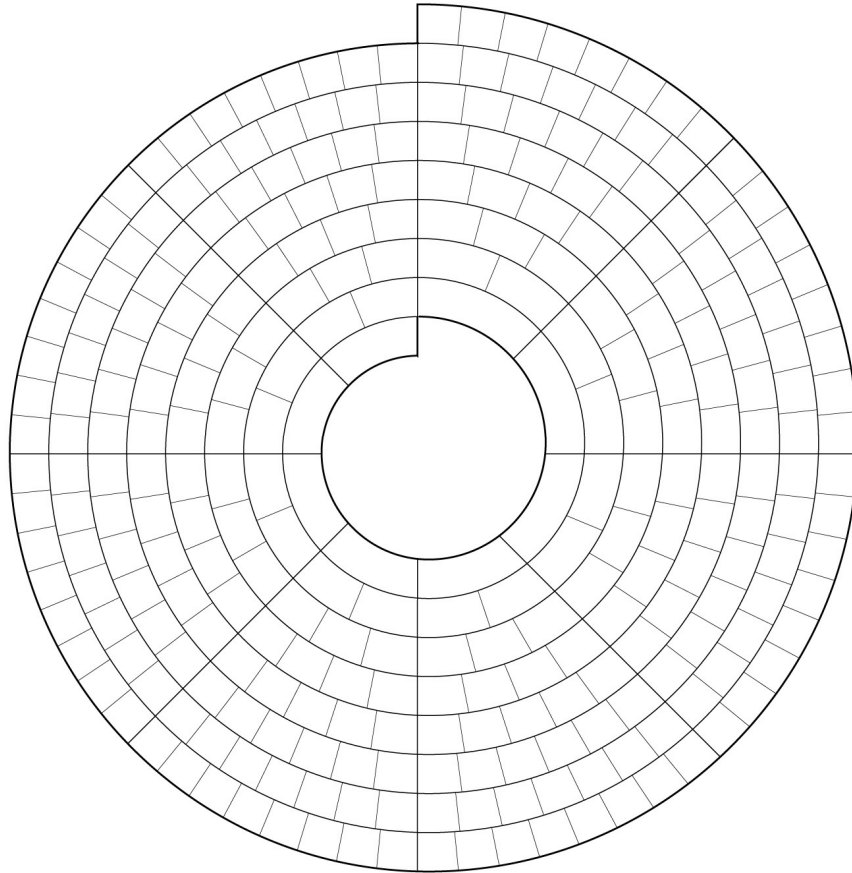

- Dial next to "Bass" on a stereo (6)
- Free of charge (6)
- Prosimian native to Madagascar (5)
- Instrument for blowing reveille (5)
- Miff (6)
- Five-staged emotion (5)
- Tendency to remain at rest (7)
- Closed to the public, like some wealthy communities (5)
- Starship captain played by Stewart (6)
- Losing money (8, three words)
- A whole that is greater than the sum of its parts (7)
- Physical consequence of excess drinking (7, two words)
- Mojito ingredients (5)
- Phineas's stepbrother on TV (4)
- Titular Bond villain (10)
- Museum purview (7, two words)
- Represent, as in a mural (6)
- Slope of a road (8)
- Very best (8)
- Diving bird (5)
- Able to be combined like oil and vinegar (9)
- One who copies notes illegally (6)
- Baby (6)
- Extremely cold (6)
- Jam ingredient (6)
- Sale item indicators (7, two words)
- Wish for a do-over (6)
- More like B.B. King's music (8)
- Having relations with, slangily (7)
- Riding the whitewater
- Make the call
- Slight bit of color
- All the world is one
- Like a subgenre of crime novels (hyph.)
- Ship's prison
- Unhappily excited
- 4, for example
- Savings, especially for a home (2 wds.)
- Type of pitcher
- Get rid of items you didn't want, in a way
- Accusing, legally
- Rachmaninoff, for one
- Pretend
- Glad holiday greetings
- Your answer, or what you've been doing with these letters

FROM THE DESK OF MYSTIK SPIRAL

Dear Fellow Rockers -

Trent from Mystik Spiral here. So it's about time we told you... Anthony thinks he's the brains behind our act, but really he couldn't songwrite his way out of a paper bag. (Seriously. We put a bag on his head once and it was still there a week later.) In fact, he tried to write you some second lines to go with the first lines you've been finishing up all day. We feel like he was on the right track with each of them, but frankly, something's a little... off.

On the other hand, if there's one thing Anthony knows, it's how to assemble a setlist. These lines may need some work, but the songs they're supposed to go into will probably make a great nine-song set.

However, if you're going to win the Baphl of the Bands, you're also going to need an encore... one great cover song to wrap things up with. I think the answers you found when solving today probably hold the key. Take a good hard look at the setlist, up and down, from beginning to end, and hopefully you can figure out how to finish the set.

Once you have your ordered list of ten songs (nine originals and a cover), write it on the attached sheet, check in with the venue manager at the Middle East, and you'll be ready to rock!

Second Lines to Songs

1. I'm ready now to go back to your apartment
2. I'll make a speech for you behind this dais
3. Would you like to take a ride in my Corvette
4. You need only provide me with some motivation
5. I'm thrilled to see you every time we're eating
6. To be with you I'd gladly cross the sea
7. Come home with me, we'll cuddle and watch Letterman
8. I once was trapped, but now you broke my chains
9. I want you to become part of my entourage

BAPHL of the Bands Final Setlist

Song 1:

Song 2:

Song 3:

Song 4:

Song 5:

Song 6:

Song 7:

Song 8:

Song 9:

ENCORE: